

# PHOENIX

## EPTOS Dossier Management System

Guido Szamocki / C. Courtney



# EPTOS 8 Training

- **PHOENIX overview**
- **PHOENIX components**
- **Databases**
- **Services**
- **MADRAS Client**
- **Interfaces**

# PHOENIX overview

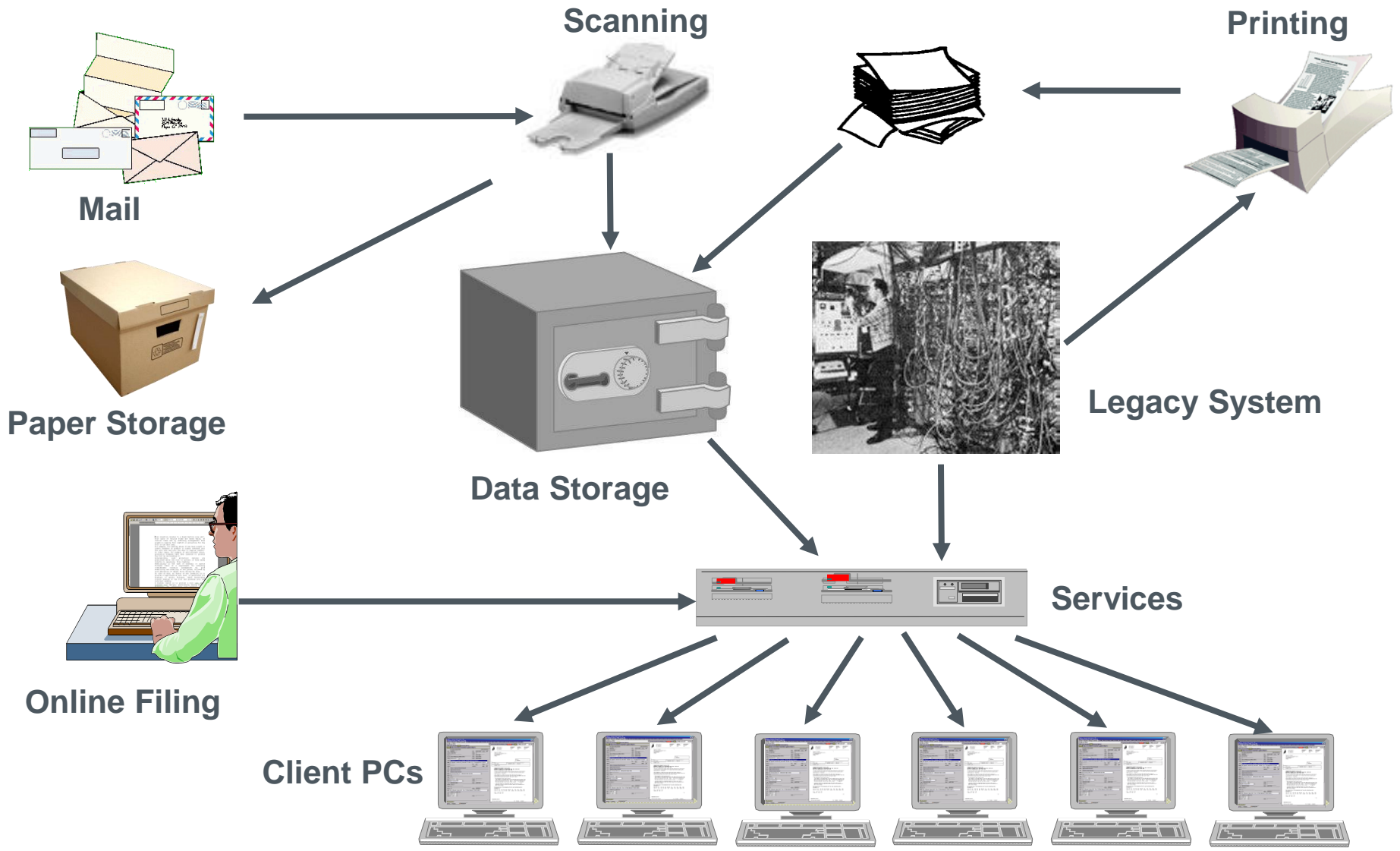

# PHOENIX Components

**Databases**

**Interfaces**

**Services**

**Clients**

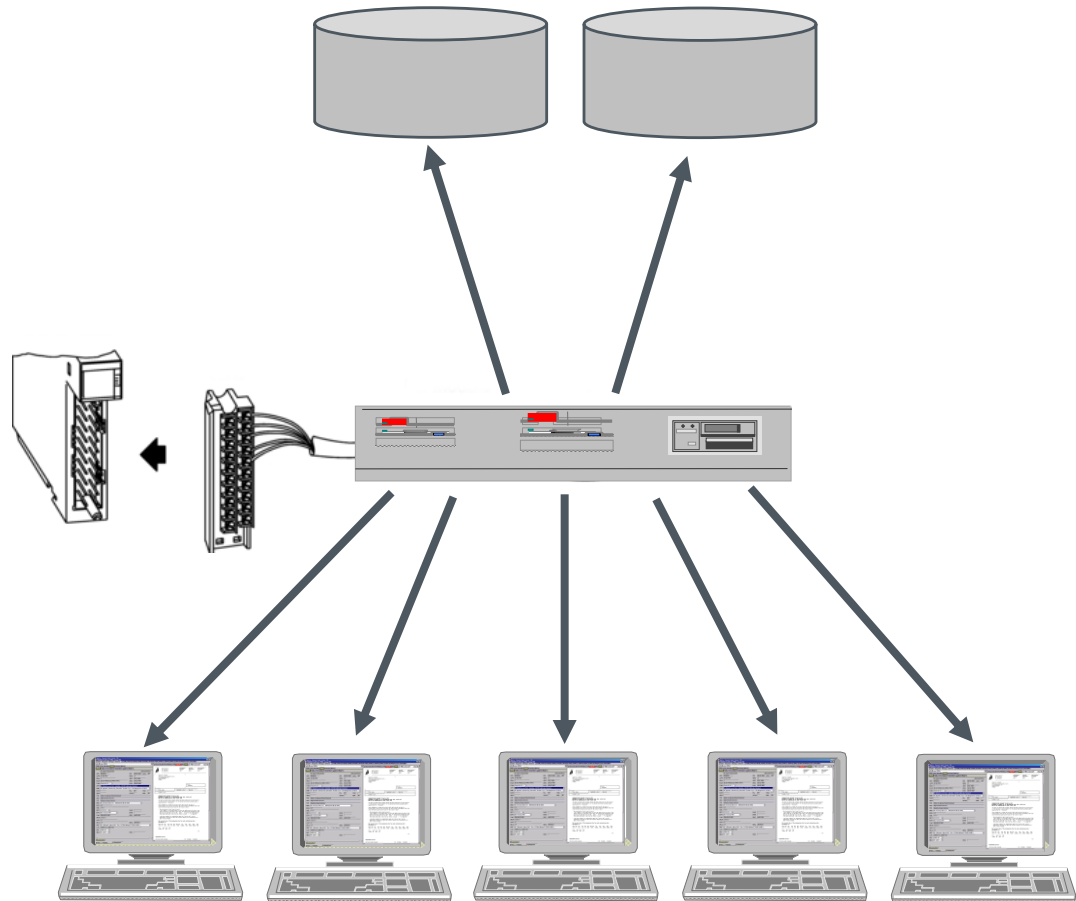

# PHOENIX Databases

- **Two Databases**

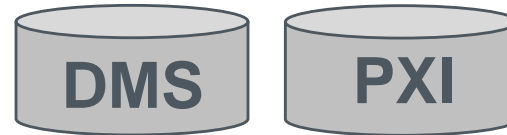

- **DMS**

- **Dossier Management System**

- **PXI**

- **Image Archive**

- **TIFFS mainly but also BLOBs**

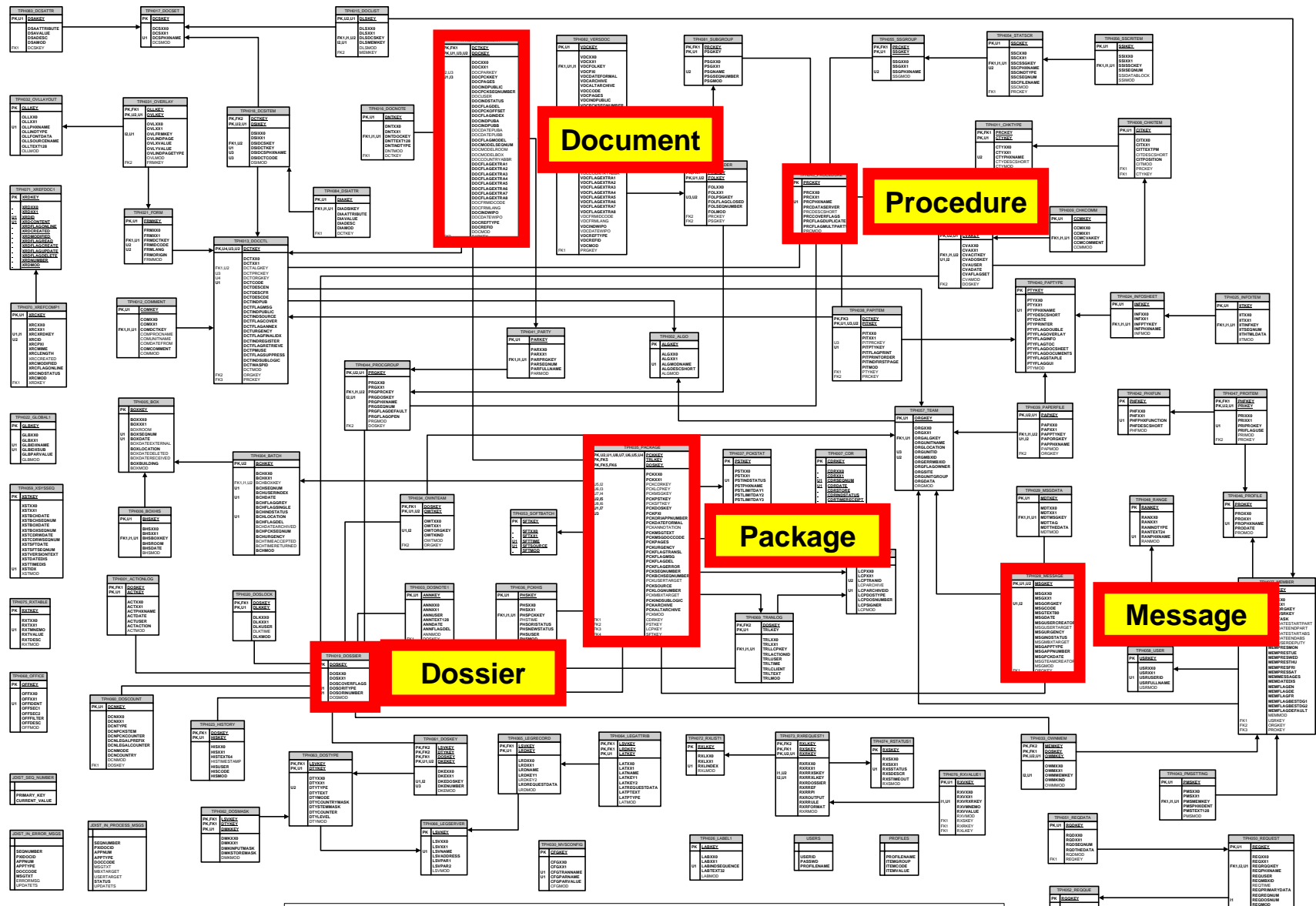

PHOENIX DMS v8.6 Logical Database Schema

# PHOENIX Components

**Databases**

**Interfaces**

**Services**

**Clients**

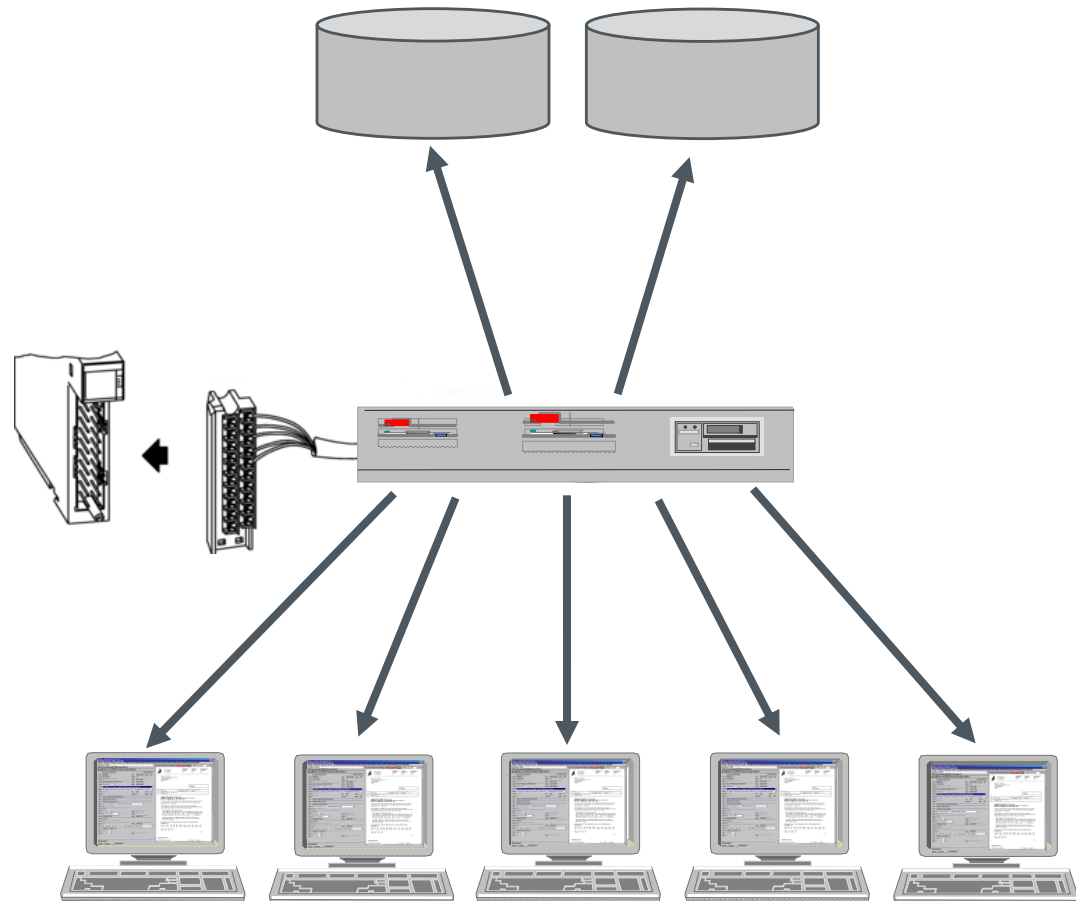

# PHOENIX Services

- **A set of Java services**
- **A service for each task**



# PHOENIX Services

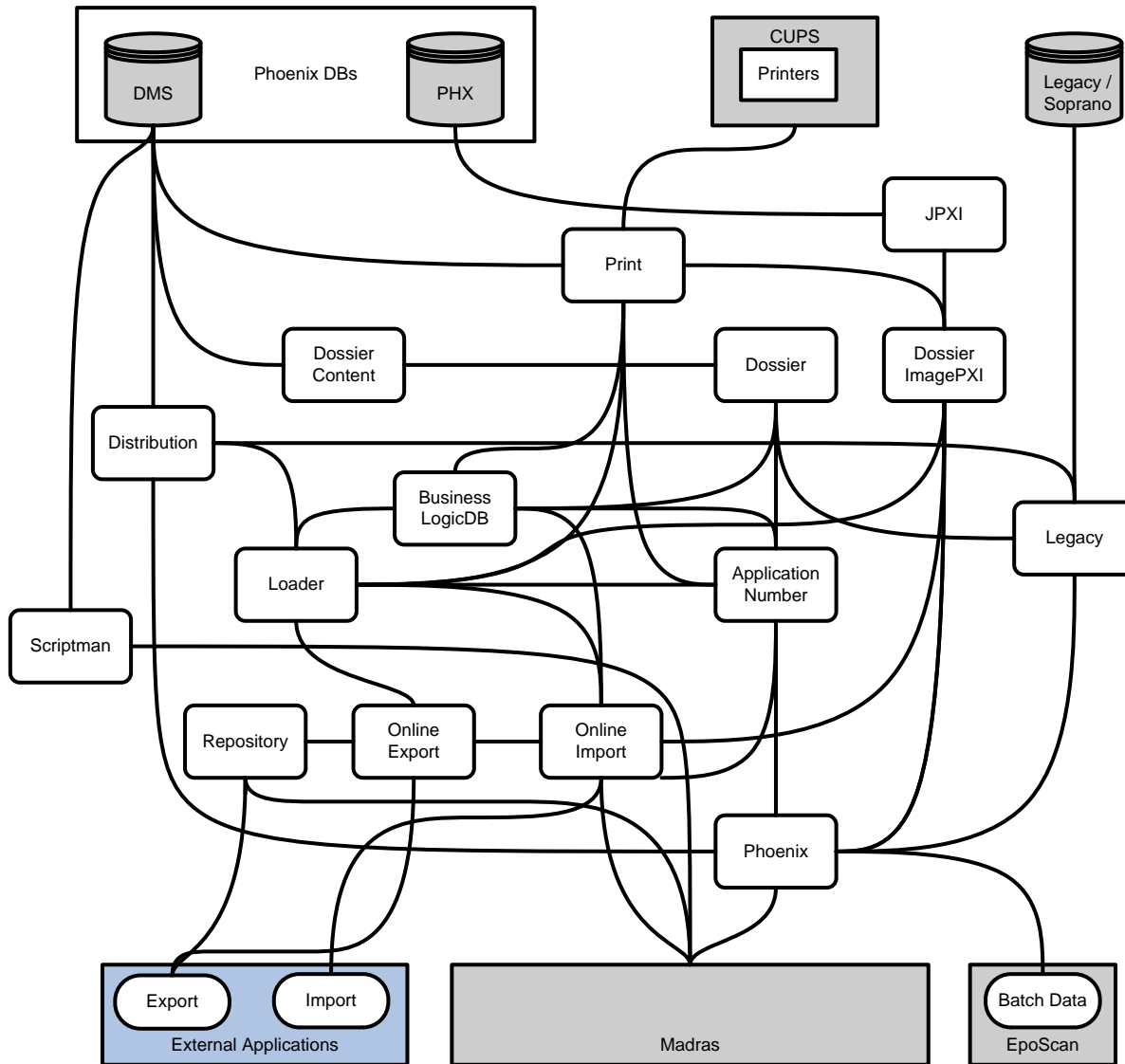

# PHOENIX Components

**Databases**

**Interfaces**

**Services**

**Clients**

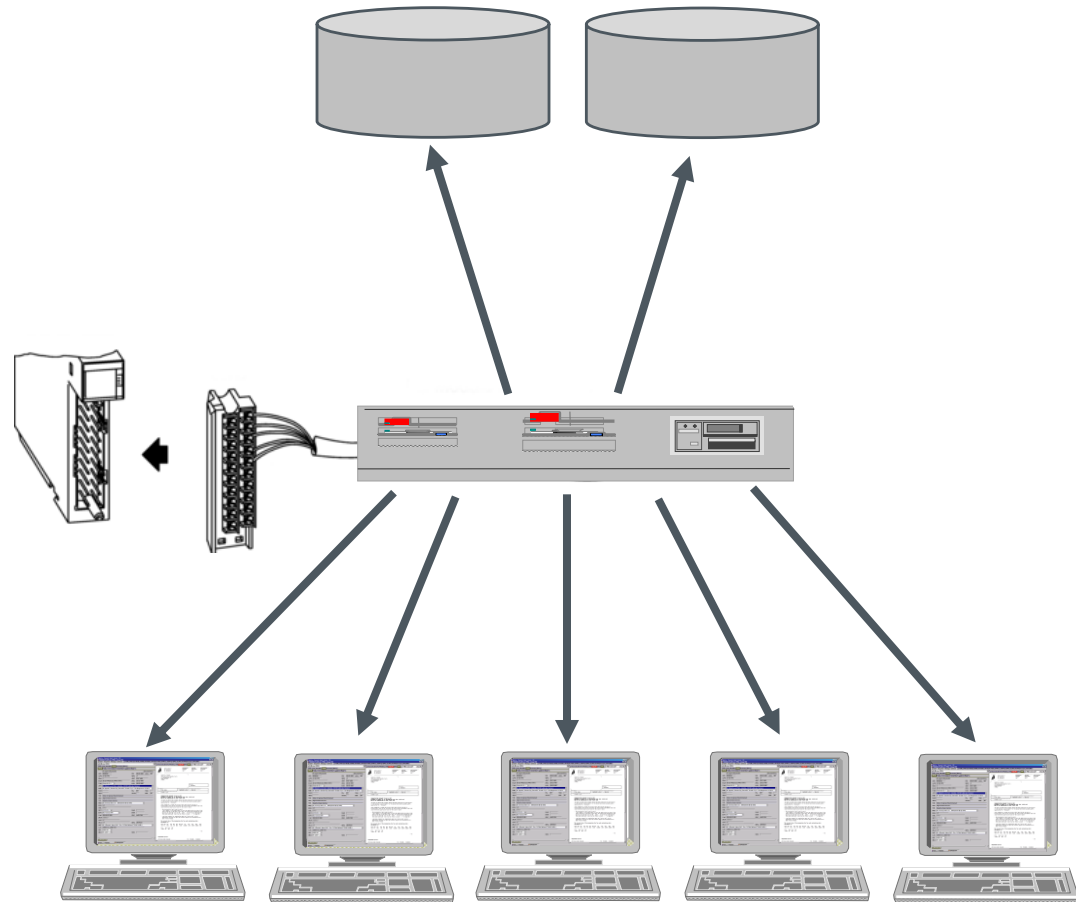

# PHOENIX Clients

- **MADRAS**
- **Full Java**

Dossier Document Message Windows Help ADM JDEWP MUSE MACH1 MACH2 POST NUF1

Cover TOC Checklist Status Structure History

Search/Exam All

Show: Active

Date	Pages	Code	PackageID	SeqNr.	LogPkg.	Handled by	Annotation
09-11-2006	38	A2PAMP...	E1210EE5C164A1P1	1	16	LV50776	20 clms; not classified ⇒ WI
27-11-2006	26	PRIO05...	E1110F29B72F59P1	1	17	LV50776	prio05 coded ⇒ WI
19-04-2007	1	A3PAMP...	E111121E515B99P1	1	28	LV50776	CLSS & PACT(02) coded ⇒ WI
19-04-2007	6	ISR	E111121E515B99P1	2	28	LV50776	EP ⇒ WI
14-09-2007	3	1201-1	E12114F1AA3ECDP1	1	29	LV50776	⇒ EF
13-11-2007	7	IPRP	E121163993C8D3P1	1	30	LV50776	/ ⇒ WI
26-11-2007	3	1200P	E111167B85B580P1	1	31	LV50776	coded (tsub2) ⇒ EC
26-11-2007	1	RECEIP...	E121167B85C264P1	1	36	LV50776	/ ⇒ EC
04-12-2007	2	PAYMEP	E12116A2DFE0DBP1	1	40	LV50776	fee,10clms,dest all,exam(O ⇒ EF
07-12-2007	1	1204	E12116A32BC85FP1	1	42	LV50776	⇒ EF
07-12-2007	1	1204	E11116A32DA9C4P1	1	43	LV50776	⇒ EF
12-12-2007	2	RPUB01...	E12116CB7E983FP1	1	45	LV50776	coded ⇒ DE
28-12-2007	2	1226	E12116EC66898CP1	1	47	LV50776	EUCL coded ⇒ SE
02-01-2008	1	1219	E11116FA49B4BEP1	1	48	HS22098	⇒ EF
11-01-2008	1	CD-FREP	E111183C0CCFE1P1	1	50	HS22098	registered / cdr ⇒ CC
19-02-2008	1	12549	E11118339A3C18P1	1	49	HS22098	⇒ EF
28-04-2008	2	2001	E111197A62F0E6P1	1	51	NM50245	⇒ JC
28-04-2008	1	12906	E121197A62F899P1	1	52	NM50245	⇒ JC
04-08-2008	1	11038	E1111B8C9DA86CP1	1	53	HS22098	⇒ EC
04-08-2008	1	EXRE92	E1211B8C9DA86FP1	1	54	HS22098	to m06/wh ⇒ EC
04-08-2008	1	RECEIP...	E1211B8C9DAEB8P1	1	58	HS22098	⇒ EC
08-08-2008	1	12944A	E1111B91B16057P1	1	61	HS22098	wh ⇒ EF
14-10-2008	1	11038	E1111CFA961825P1	1	62	HS22098	⇒ EC
14-10-2008	5	EXRE3	E1111CFA96237CP1	1	64	HS22098	to exam. - HS ⇒ EC
14-10-2008	3	CLMS	E1111CFA96AEDCP1	1	66	HS22098	⇒ EC
14-10-2008	1	RECEIP...	E1111CFA96AF09P1	1	67	HS22098	⇒ EC
09-10-2009	2	CDAPPR...	E111244C844C55P1	1	72		registered / cdr ⇒ CC
15-10-2009	1	12548	E11124485CCE49P1	1	71		⇒ EF
15-10-2009	2	CDAPPR...	E121247AD040B2P1	1	73		registered / cdr / conf ⇒ CC

coded (tsub2)

PCTRO PCTISA Search/Exam

Search/Exam, 04-08-2008



Europäisches Patentamt

European Patent Office

Office européen des brevets

**Acknowledgement of receipt**

We hereby acknowledge receipt of the following subsequently filed document(s):

Submission number	425534	
Application number	EP06753455.2	
Date of receipt	04 August 2008	
Receiving office	European Patent Office, The Hague	
Your reference	360EP	
Applicant	All applicants as on file	
Documents submitted	package-data.xml	ep-sfd-request.xml
	epf1038.pdf (1 p.)	EXRE92-1.pdf360 EP.pdf (1 p.)
Submitted by	CN=B. Michi 5924,O=Bracco Imaging SpA,C=IT	
Method of submission	Online	
Timestamp of receipt	04 August 2008, 09:27:02 (CEST)	
Digest	00:59:E6:83:87:D3:29:79:E0:AF:E5:05:20:4A:56:27:57:AA:F6:56	

/European Patent Office/

# PHOENIX Components

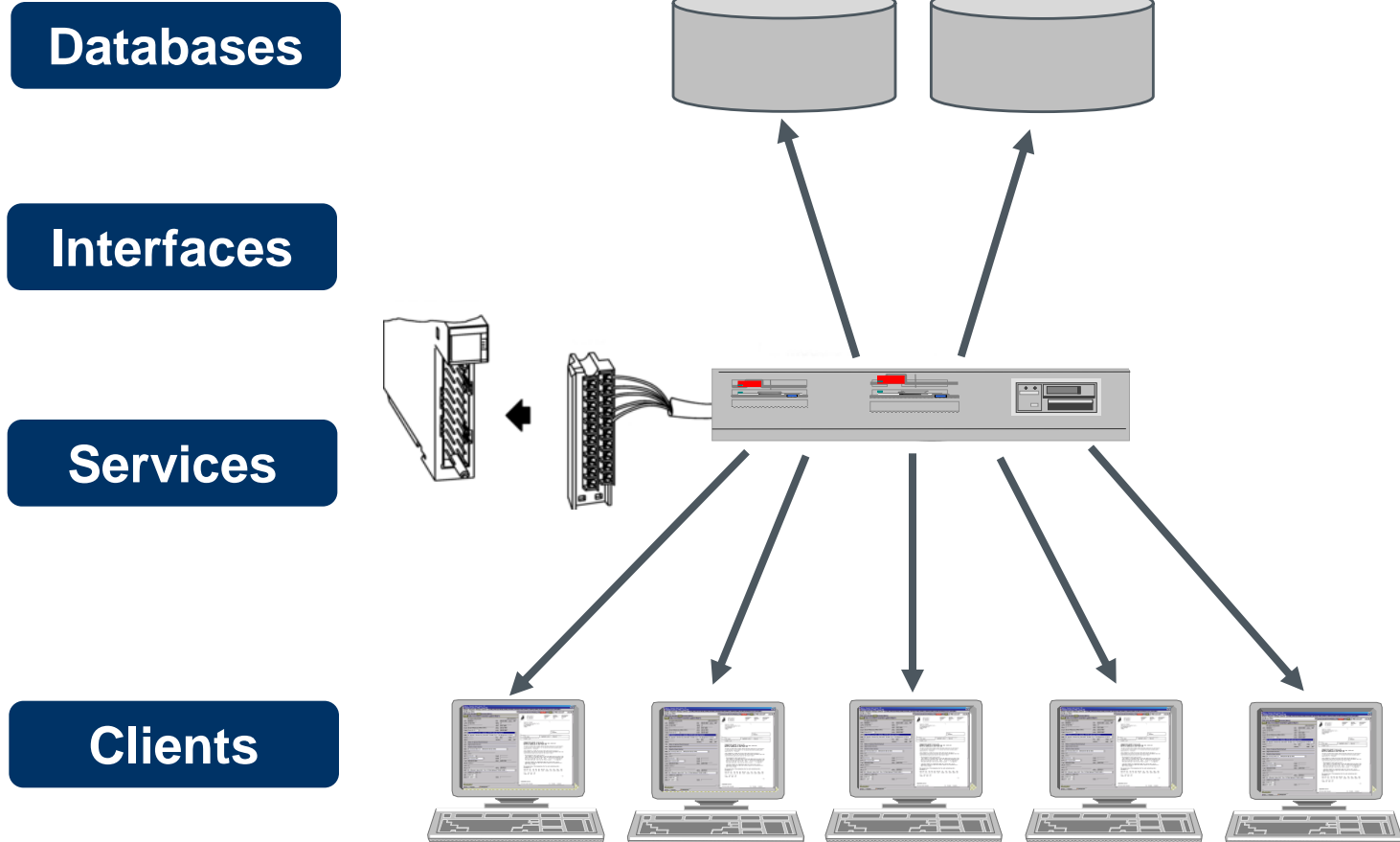

# PHOENIX Interfaces

- **Legacy interface**

# Legacy Interface

- **Access to all Dossier information**
  - Read only
- **Only way to access Procedural data**
- **The Legacy Service delivers data elements**
  - Date of Filing
  - Applicant details
  - Fees
  - etc.

# Legacy Interface

## Legacy System

```
Session A - [24 x 80]
File Edit View Communication Actions Window ZipPrint Help
(5002030) E P A S Y S 20/11/02-1523
===== BIBLIOGRAPHIC DATA OF APPLICATION: 01122234.6 (= EP application)
=====
SUSI: 00.00.00(00.00.00)// RESU: 00.00.00(00.00.00)//
MEPA: 00.00.00
0.00.00)/00.00.00
.00.00 COPD: 18.03.02
DREC: 17.09.01
EXAM: 17.09.01/17.09.01//
AREF: EP22195-013/kj
Fuji-shi, Shizuoka 417-0023
JP
PADR: (NO PADR)
FREP: 01/00100721.0(17.09.01)/17.09.01/
Grünecker, KinKeldey, f Stockmair & fSchwanhäusser Anwaltssozietät
ENTER = NEXT PAGE PA2 = END OF DATA PAGE: 1
MA a 01/001
Connected to remote server/host gma using port 6023
```

Legacy Service

## MADRAS

### Status Screen

DREC	17.09.2001
EXAM	17.09.2001 / 17.09.2001
AREF	EP22195-013/kj



# PHOENIX Interfaces

- **Legacy interface**
- **Import interface**

# Import Interface

- **Load Documents only**
- **Document Contents**
  - **TIFF**
  - **PDF**
  - **PostScript**
  - **BLOB**

} converted to TIFF via Ghostscript
- **Document Data**
  - **Dossier**
  - **Date**
  - **Code**
  - **Pages**

} minimum but can be more

# PHOENIX Interfaces

- **Legacy interface**
- **Import interface**
- **Export interface**

# Export Interface

- Export documents and BLOBs only
- IPX Format
- Limited content

- Dossier
- Date
- Document codes

```
<?xml version="1.0" encoding="UTF-8" ?>  
- <Application SendingOffice="EP" LocalNumber="FRA0705100">  
  <Package LegalDate="20080317">  
    - <Document LocalCode="FR237-1" Code="9999" Format="TIFF">  
      <Page Location="ipx1.tiff" />  
    </Document>  
    - <Document LocalCode="FR237-2" Code="9999" Format="TIFF">  
      <Page Location="ipx2.tiff" />  
    </Document>  
    - <Document LocalCode="FR237-3" Code="9999" Format="TIFF">  
      <Page Location="ipx3.tiff" />  
    </Document>  
  </Package>  
- <Package LegalDate="20080313">  
  - <Document LocalCode="FR_P0410M" Code="9999" Format="TIFF">  
    <Page Location="ipx4.tiff" />  
  </Document>  
  - <Document LocalCode="FR_1503" Code="9999" Format="TIFF">  
    <Page Location="ipx5.tiff" />  
  </Document>  
  - <Document LocalCode="FR_P0459" Code="9999" Format="TIFF">  
    <Page Location="ipx6.tiff" />  
  </Document>  
</Package>  
</Application>
```

# Export Interface

- **Export documents and BLOBs only**
- **IPX Format**
- **Limited content**
- **Export by fixed subsets**
- **Export by configurable "rules"**